

TOP VIEW

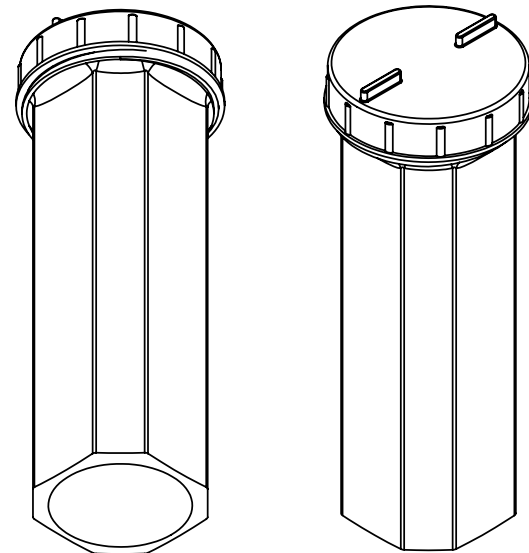

ISOMETRIC VIEWS

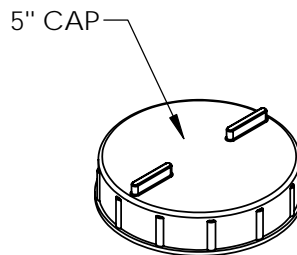
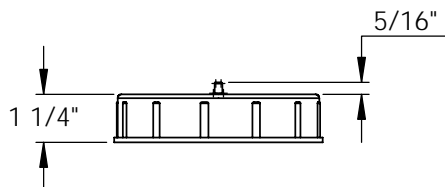
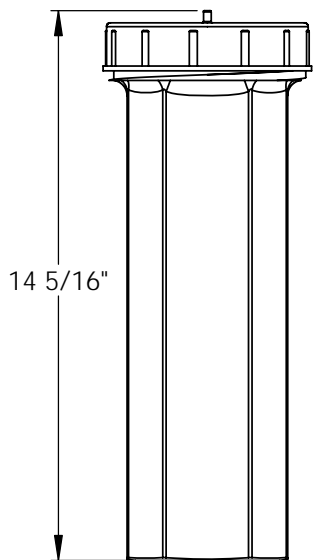

FRONT VIEW

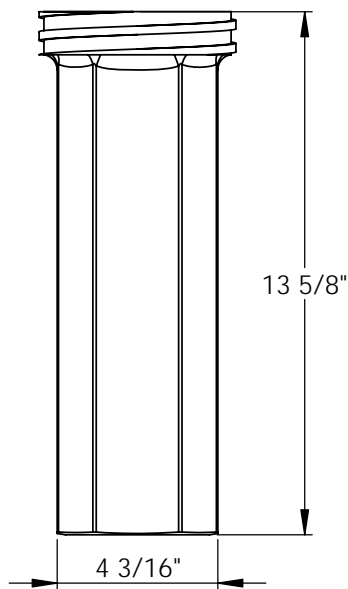

SIDE VIEW

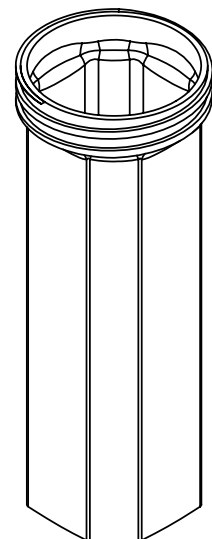

ISOMETRIC VIEWS

Copyright © 2008 Quality Molded Plastics LTD.

<b>PROPRIETARY AND CONFIDENTIAL</b> THE INFORMATION CONTAINED IN THIS DRAWING IS THE SOLE PROPERTY OF QUALITY MOLDED PLASTICS LTD. ANY REPRODUCTION IN PART OR AS A WHOLE WITHOUT THE WRITTEN PERMISSION OF QUALITY MOLDED PLASTICS LTD. IS PROHIBITED.	CLIENT NAME: <b>Q.M.P.</b>	MATERIAL: LLDPE	DATE: NOV/18/2008	DRAWN BY: JOSE H.	DESCRIPTION: <b>TUBE ASSY, DOCUMENT, 5x13</b>	REV <b>Y</b>
	APPROXIMATE WEIGHT (lb): 1.5	DO NOT SCALE DRAWING				
	<b>UNLESS OTHERWISE SPECIFIED:</b>		 <b>QUALITY MOLDED PLASTICS LTD.</b> Site 412, P.O. Box 280, R.R.#4 SASKATOON, SK S7K 3J7		SCALE: 1:10	PART NO.
	--- TOLERANCES --- LENGTH DIMENSION: ± 1% ANGULAR: ± 1.0°	DIMENSIONS ARE IN INCHES			SHEET 1 OF 1	<b>60117-1</b>